

SPEED CONTROLLERS FOR INDUSTRIAL FANS

SCNR (CA-CA-V0)

Non reversible variable electronic speed controller

Model	Code	V ~ 50 Hz	W	kg	Insulation
SCNR	12912	220-240	200	0.2	cl.II

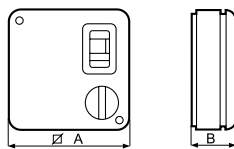

Dimensions (mm)

Product	Code	∅ A	B
SCNR	12912	120	43

(except code 16061)

SCNRB (CA-CA-V0)

Flush fitting non reversible variable electronic speed controller

Model	Code	V ~ 50 Hz	W	kg	Insulation
SCNRB	12971	220-240	200	0.2	cl.II

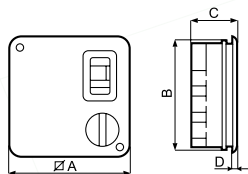

Dimensions (mm)

Product	Code	∅ A	B	C	D
SCNRB	12971	142	135	59.5	4.5

TR-CV (TR - TR-ED)

2 speed controllers with 3-position selector (0 - 1 - 2)

Model	Code	V ~ 50 Hz	kg	Insulation	IP
TR-CVM	22900	220-240	0.2	cl.I	65
TR-CVT	22910	380-415	0.2	cl.I	65

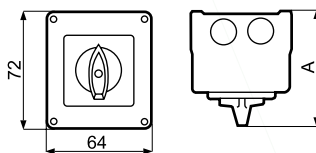

Dimensions (mm)

Product	Code	A	Posit.
TR-CVM	22900	82	0 1 2
TR-CVT	22910	92	0, 1 g

IR

Speed controllers - neon indicator and 4-position selector (0 - 1 - 2 - 3) - complete with interchangeable clamp to fit most sizes of cable - wall-mounting fixings included.

Model	Code	V ~ 50 Hz	A	kg	Insulation	IP
IRM30	12921	220-240	1.2	3.8	cl.I	56
IRM40	12922	220-240	3.5	6.1	cl.I	56
IRM50	12928	220-240	4.8	6	cl.I	56
IRT15	12923	380-415	0.75	6.3	cl.I	56
IRT35	12924	380-415	2.6	11	cl.I	56
IRT40	12927	380-415	4.5	13	cl.I	56

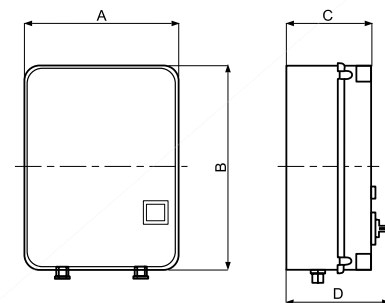

Dimensions (mm)

Product	Code	A	B	C	D
IRM 30	12921	200	254	99	128
IRM 40	12922	236	315	128	157
IRM 50	12928	236	315	128	157
IRT 15	12923	236	315	128	157
IRT 35	12924	236	315	128	157
IRT 40	12927	236	315	128	157

IREM Single-phase speed controller

Electronic single-phase controllers - can be used to regulate one more motors - neon indicator light and trimmer to pre-set the minimum fan speed - spacer and fixings provided.

Model	Code	V ~ 50 Hz	A	kg	Insulation	IP
IREM 3	12931	220-240	3	0.4	cl.I	54
IREM 5	12932	220-240	5	0.4	cl.I	54
IREM 9	12933	220-240	9	0.7	cl.I	54
IRET 6	12934	380-415	6	0.7	cl.I	54

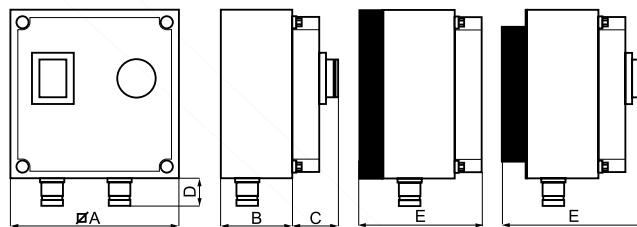

Dimensions (mm)

Product	Code	∅ A	B	C	D	E
IREM 3	12931	125	57	31	25	-
IREM 5	12932	125	57	31	25	-
IREM 9	12933	125	-	-	25	103
IRET 6	12934	175	-	-	30	105

Controllers C0 5 (code 12987) / C1 5 (code 12966)

- **Non-Reversible variable electronic speed controller.**
- Can be connected to any domestic fan with a single phase motor with maximum of 200 W.
- Not suitable for products with timer or automatic shutters.
- 220-240 V 50 Hz.
- Double insulation.
- Weight kg. 0.2.

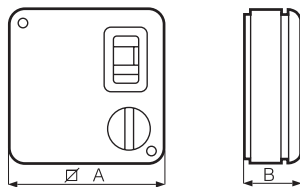

Dimensions (mm)

Code	∅ A	B
12987	120	43
12966	120	43

SCNRB Non-reversible (built-in) (code 12971)

- **Specification as the C1.5 non-reversible.**
- Flush fitting.
- Weight kg. 0.25.

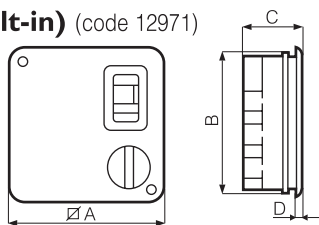

Dimensions (mm)

Code	∅ A	B	C	D
12971	142	135	59.5	4.5

SCNR/M (code 12982) / C2 5 (code 12967)

- **Non-Reversible variable electronic speed controller.**
- Convertible to flush-mounted using SCB5 Kit.
- 220-240V 50 Hz.
- Maximum load: 450W
- Weight: 0.2 kg.
- Double insulation

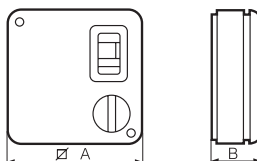

Dimensions (mm)

Code	∅ A	B
12982	120	43
12967	120	43

Kit SCB (code 22481) and SCB5 (code 22483)

- **Kit to convert SCR5/C1.5 to built-in model.**

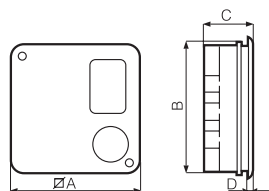

Dimensions (mm)

Code	∅ A	B	C	D
22481	142	135	59.5	4.5
22483	142	135	59.5	4.5

DUO (cod. 22914)

- two speeds switch
- on/off switch

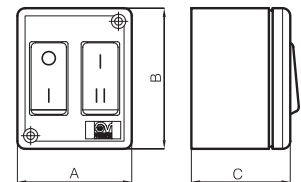

Dimensions (mm)

Code	A	B	C
22914	52	64	45

Air flow deflector (code 22310-22320)

- **For fitting to the delivery side of extractor fans to direct the air flow in any required direction within 360°**
- Weight kg. 0.2.

Design: F. Trabucco - M. Vecchi

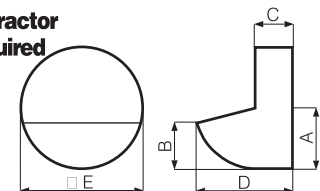

Dimensions (mm)

Code	A	B	C	D	∅ E
22310	49.5	37	30	77	99
22320	59.5	44	30	87	119

Gravit Grille (code 22140)

- **For outside walls. The shutters are automatically opened when the product is switched on.**
- 22140 (3,5"-10 cm)
- Weight kg. 0.1. ▪ Grey.

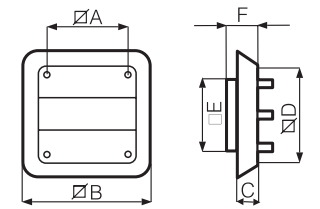

Dimensions (mm)

Code	∅ A	∅ B	C	∅ D	∅ E	F
22140 GGR10	94	149	23.6	115	95.5	33.5

Air entr grille (code 22114-22113)

- **Includes a grille with a protective screen for fixing to the external wall and one for fixing inside the room.**

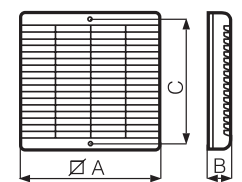

Dimensions (mm)

Code	∅ A	B	C
G 23/9" - 22114	291	31	241
G 30/12" - 22113	370	31	308

Grille it

- (∅ 100 code 22140 - ∅ 120 code 22141 - ∅ 150 code 22142 - ∅ 90 code 22143)

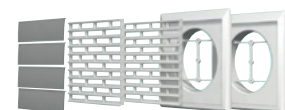

Fixed grille (code 22010-22020)

- **For outside walls.**
- 22010 (4"-10 cm)
- 22020 (5"/6"-12/15 cm)
- Weight kg. 0.1.
- Grey.

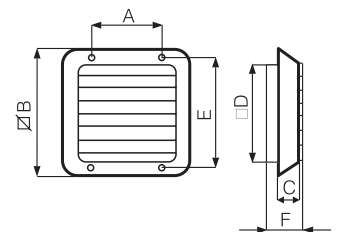

Dimensions (mm)

Code	A	∅ B	C	∅ D	E	F
22010 GFI	100	150	24	97	133	50
22020 GFI	110	197	30	155	180	